

902

»» Features



- Long terminals for ideal for soldering and mounting reliability.
- High dielectric strength between coil and contacts (2000VAC) and between contacts of different polarity (1500VAC).
- High impulse withstand voltages between coil and contacts, and between contacts of different polarity (2500V, 2x10 μ s: Bellcore requirements).
- Low power consumption (140mW).
- Bifurcated crossbar contact (Au-clad) and plastic sealed construction for high reliability.
- High seal ability after IRS.
- Comply with RoHS-Directive 2002/95/EC.

»» Type List

Terminal style	Contact form	Relay function	Terminal shape	Enclosure style
				Plastics sealed
PCB terminal	2C (DPDT)	Single-side stable	-----	902-2C-S
				902-2C-S-Y
		Single-winding latching	-----	902U-2C-S
		Double-winding latching	-----	902K-2C-S
	Single-side stable	Outside-L surface mounting terminal	902F-2C-S	902F-2C-S-TR

»» Ordering Information

902 - 2C - S - -
 1 2 3 4 5 6 7

- | | |
|------------------------------------|-----------------------------------|
| 1. 902 -- Basic series designation | 4. 2C -- Double pole double throw |
| 2. Blank -- Single-side stable | 5. S -- Plastics sealed |
| U -- Single-winding latching | |
| K -- Double-winding latching | 6. Blank -- Standard type |
| | TR -- Tape packing |
| 3. Blank -- PCB terminal | |
| F -- Surface mount terminal | 7. Blank -- UL/CUL approved |
| | Y -- EN60950 approved |

»» Contact Rating

Rated load (resistive load)	0.5A at 125VAC, 2A at 30VDC
Contact material	Ag + Au-clad
Max. continuous current	2A
Maximum switching voltage	250VAC, 220VDC
Maximum switching capacity	62.5VA, 60W
Min. permissible load ⁽¹⁾	10 μ A at 10mVDC

Note : (1) P level: $\lambda_{60} = 0.1 \times 10^{-6}$ / operation

»» Coil Rating (DC)

◆ Single-side stable

Rated voltage (V)	Rated current $\pm 10\%$ at 23°C (mA)	Coil resistance $\pm 10\%$ at 23°C (Ω)	Max. continuous voltage at 23°C	Pick up voltage(Max) at 23°C	Drop out voltage(Min) at 23°C	Power consumption at rated voltage
4.5	31	145	200 % of rated voltage	75 % of rated voltage	10 % of rated voltage	approx. 0.14W
5	28.1	178				
12	11.7	1028				
24	8.3	2880	170 % of rated voltage			approx. 0.2W

◆ Single-winding latching

Rated voltage (V)	Rated current $\pm 10\%$ at 23°C (mA)	Coil resistance $\pm 10\%$ at 23°C (Ω)	Max. continuous voltage at 23°C	Set voltage(Max) at 23°C	Reset voltage(Max) at 23°C	Power consumption at rated voltage
4.5	22.2	203	180 % of rated voltage	75 % of rated voltage	75 % of rated voltage	approx. 0.1W
5	20	250				
12	8.3	1440				
24	6.3	3840				approx. 0.15W

◆ Double-winding latching

Rated voltage (V)	Rated current $\pm 10\%$ at 23°C (mA)	Coil resistance $\pm 10\%$ at 23°C (Ω)	Max. continuous voltage at 23°C	Set voltage(Max) at 23°C	Reset voltage(Max) at 23°C	Power consumption at rated voltage
4.5	44.4	101	170 % of rated voltage	75 % of rated voltage	75 % of rated voltage	approx. 0.2W
5	40	125				
12	16.7	720				
24	12.5	1920	140 % of rated voltage			approx. 0.3W

902

◆Single-side stable (EN60950 approved type)

Rated voltage (V)	Rated current ±10 % at 23°C (mA)	Coil resistance ±10 % at 23°C (Ω)	Max. continuous voltage at 23°C	Pick up voltage(Max) at 23°C	Drop out voltage(Min) at 23°C	Power consumption at rated voltage
5	40	125	170 % of rated voltage	75 % of rated voltage	10 % of rated voltage	approx. 0.2W
12	16.7	720		rated voltage	rated voltage	approx. 0.23W
24	9.6	2504		rated voltage	rated voltage	

» Specification

Contact resistance ⁽¹⁾	75 mΩ Max. (100mA/6VDC by 4 pipes mΩ meter)	
Operate time ⁽¹⁾	4 ms max.	
Release time ⁽¹⁾	4 ms max.	
Bounce time	operate : approx 0.5ms set/reset : approx 0.5ms	release : approx 0.5ms
Insulation resistance ^{(1) (2)}	1000MΩ Min. (DC 500V)	
Dielectric strength ⁽¹⁾	Between coil and contacts	: AC 2000V, 50/60Hz 1 min. : AC 1000V, 50/60Hz 1 min (double-winding latching)
	Between contact of different pole	: AC 1500V, 50/60Hz 1 min.
	Between contact of same pole	: AC 1000V, 50/60Hz 1 min.
	Between set and reset coil	: AC 500V, 50/60Hz 1 min. (double-winding latching)
Surge withstand voltage	Between coil and contacts	: AC 2500V (2X10 μs) : AC 1500V (10X160 μs) (double-winding latching)
	Between contact of different pole	: AC 2500V (2X10 μs)
	Between contact of same pole	: AC 1500V (10X160 μs) (conforms to FCC part 68)
Vibration resistance	Operating extremes	10~55Hz , double amplitude 3.3 mm
	Damage limits	10~55Hz , double amplitude 5 mm
Shock resistance	Operating extremes	75G
	Damage limits	100G
Life expectancy	Mechanical	100,000,000 operations (frequency 36,000 operations/hr)
	Electrical	100,000 operations (frequency 1,200 operations/hr)
Operating ambient temperature	-40~+85°C (no freezing)	
	-40~+70°C (no freezing) [double winding latching]	
Weight	Approx. 2 g	

Note : (1) initial value

(2) except between set and reset coil

»» Safety Approval

Certified	UL	CSA
File No.	E74321	218083

»» Safety Approval Rating

UL	CSA
2A 30VDC	2A 30VDC
0.3A 110VDC	0.3A 110VDC
0.5A 125VAC	0.5A 125VAC

»» Outline Dimensions

◆ 902,902U

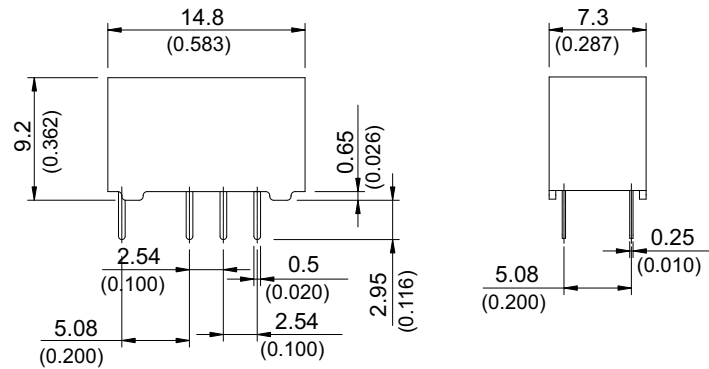

◆ 902F

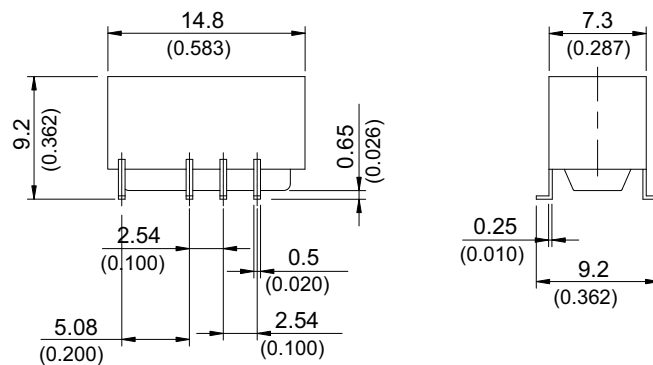

◆ 902K

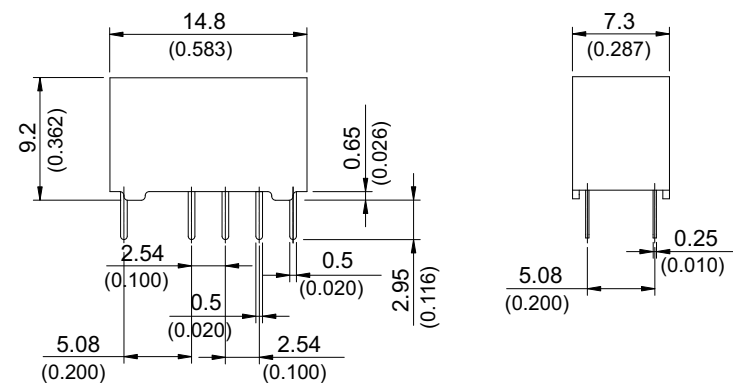

902

»» Wiring Diagram BOTTOM VIEW

◆902

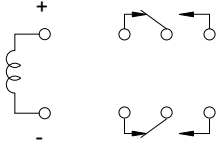

◆902F

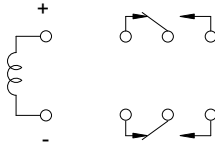

◆902U

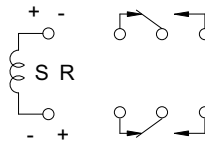

◆902K

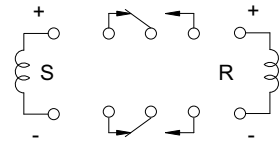

»» PC Board Layout BOTTOM VIEW

◆902,902U

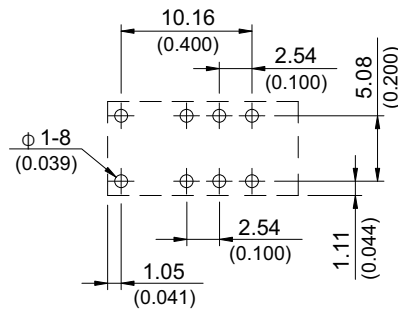

◆902F

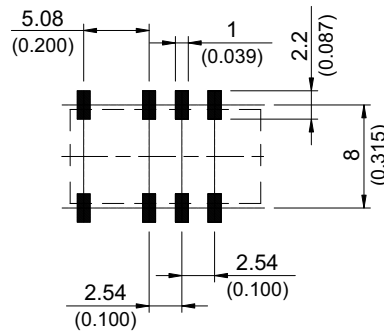

◆902K

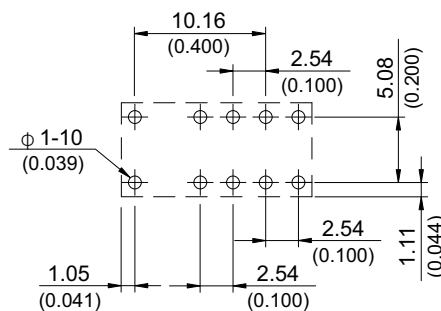

Engineering Data

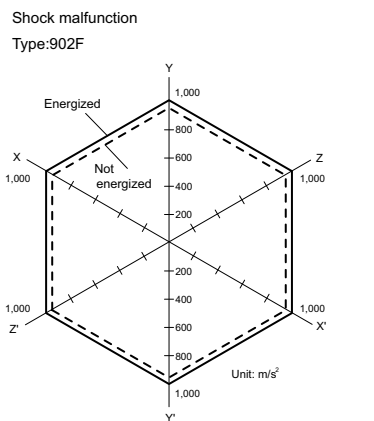
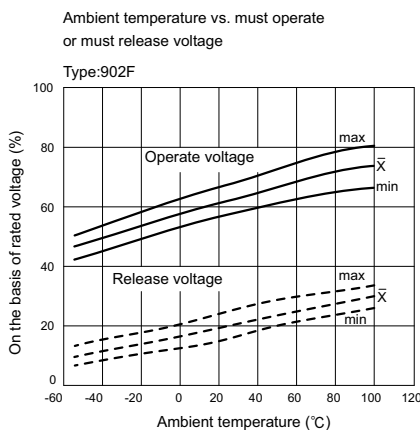
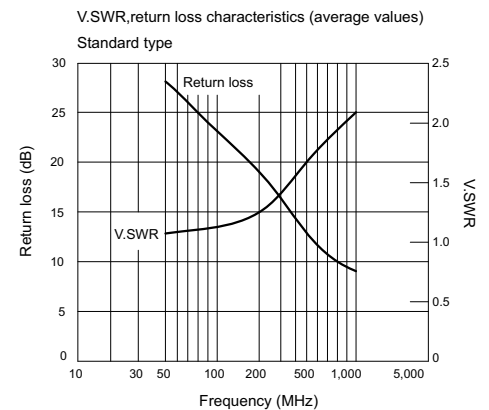
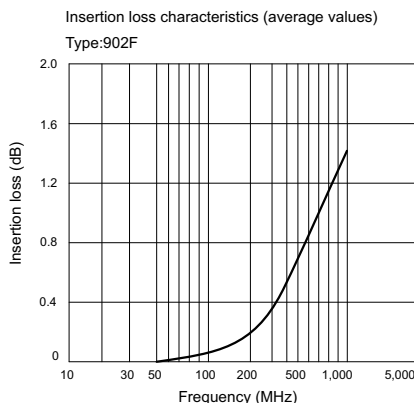
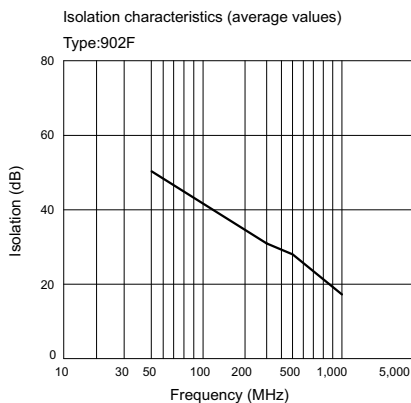
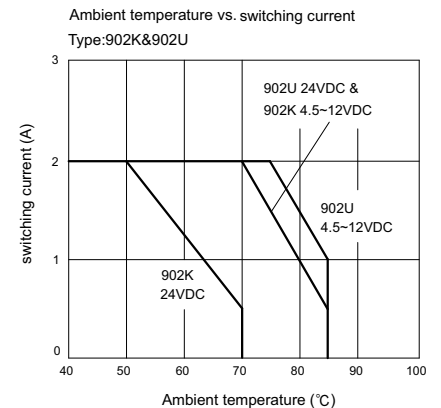
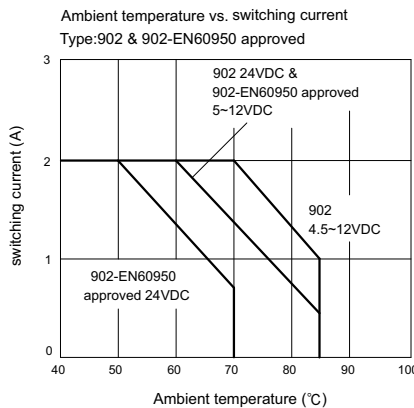
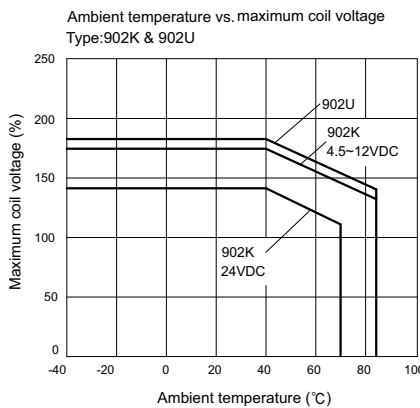
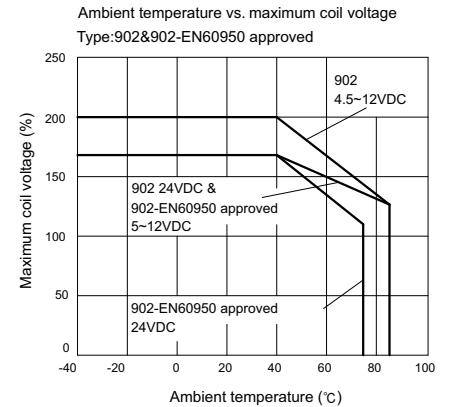
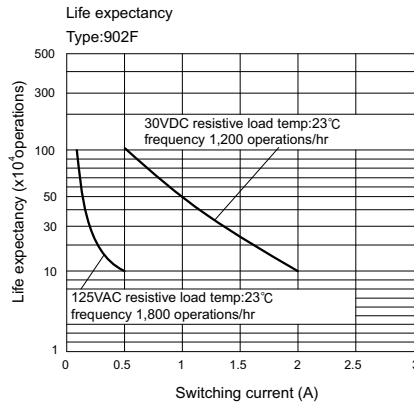
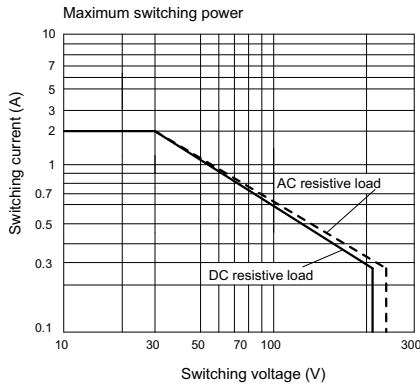

Shock direction

X ← X'

Y ↑ Y'

Z ● Z'

Z' ⊗

Conditions:
Shock is applied in +X, +Y, and +Z directions three times each with and without energizing the Relays to check the number of contact malfunctions.

902

Electrical life expectancy
(with must operate and must release voltage)
Type:902F

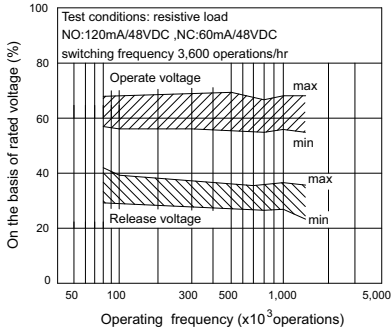

Electrical life expectancy
(contact resistance)
Type:902F

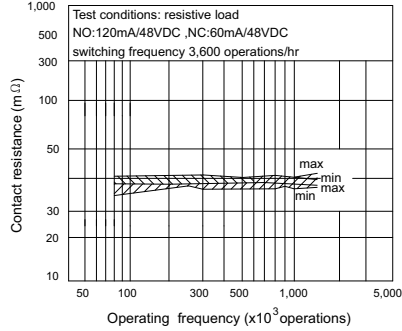

Electrical life expectancy
(with must operate and must release voltage)
Type:902F

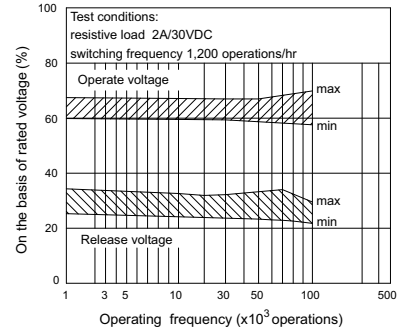

Electrical life expectancy
(contact resistance)
Type:902F

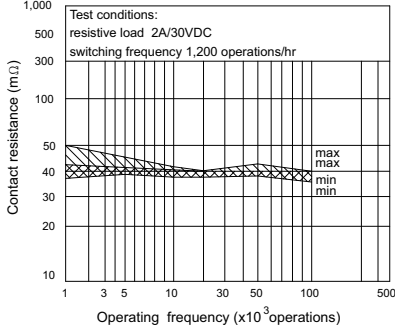

Contact reliability test
Type:902F

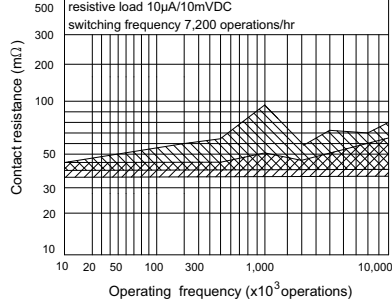

Must operate and must release time distribution
Type:902F

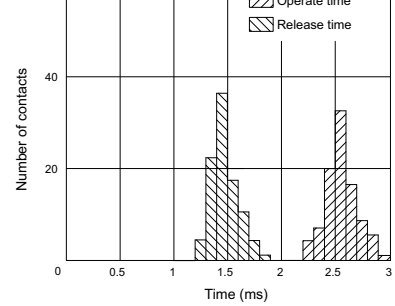

Must operate and must release bounce time distribution
Type:902F

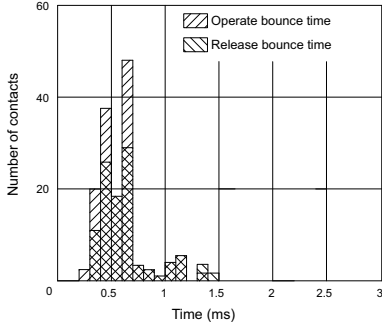

External magnetic Interference (average value)
Type:902F

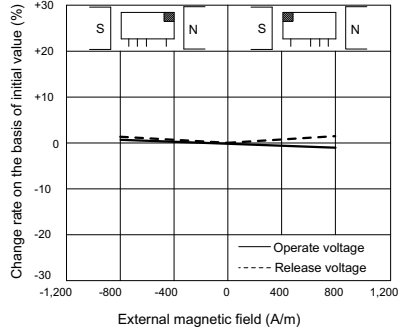

External magnetic Interference (average value)
Type:902F

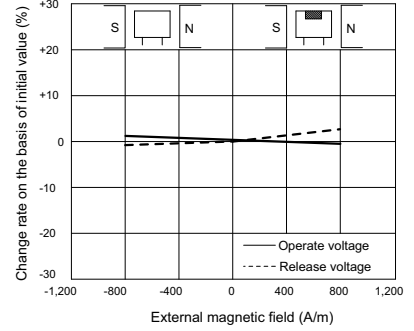

External magnetic Interference (average value)
Type:902F

