

## »» Features



- High rating general purpose miniature PCB Power Relays.
- Optional for 700mW coil and 530mW coil.
- 5mm planning 16A TV-10 ideally form high inrush current breaking application for UPS, power supply and Heading Element control of Home Appliances, and lighting controls.
- High dielectric strength 5000V between coil and contacts, 1000V between contacts.
- Optional for sealed flux free & sealed washable types.
- Comply with RoHS-Directive 2002/95/EC.

## »» Type List

Terminal style	Contact form	UL Insulation system approval	Designation (provided with)		
			Flux tight	Sealed type	Sealed type washable
PCB terminal	1A (SPNO)	-----	793-P-1A	793-P-1A-V	793-P-1A-S
		F	793-P-1A-F	793-P-1A-F-V	793-P-1A-F-S
	1B (SPNC)	-----	793-P-1B	793-P-1B-V	793-P-1B-S
		F	793-P-1B-F	793-P-1B-F-V	793-P-1B-F-S
	1C (SPDT)	-----	793-P-1C	793-P-1C-V	793-P-1C-S
		F	793-P-1C-F	793-P-1C-F-V	793-P-1C-F-S

## »» Ordering Information

793 - P - 1A -  -   
 1            2            3            4            5

- |  |   |
|--|---|
| <p>1. 793 -- Basic series designation</p> <p>2. P -- PCB terminal</p> <p>3. 1A -- Single pole normally open<br/>         1B -- Single pole normally closed<br/>         1C -- Single pole double throw</p> | <p>4. Blank -- Standard type<br/>         F -- Class F</p> <p>5. Blank -- Flux tight<br/>         V -- Sealed type<br/>         S -- Sealed type washable</p> |
|--|---|

## »» Contact Rating

Resistive load	16A 240VAC
----------------	------------

# 793

## »» Coil Rating (DC)

### ◆ Standard Type

Rated voltage (V)	Rated current ±10 % at 23°C (mA)	Coil resistance ±10 % at 23°C (Ω)	Max. continuous voltage at 70°C	Pick up voltage(Max) at 23°C	Drop out voltage(Min) at 23°C	Power consumption at rated voltage
3	234	12.8	160 % of rated voltage	75 % of rated voltage	10 % of rated voltage	approx. 0.7W
5	139	36				
6	118	51				
9	78	116				
12	58	206				
18	39	463				
24	29	825				
48	15	3,300				
60	11.7	5,100				
100	7.5	13,400				

### ◆ High Sensitivity Type

Rated voltage (V)	Rated current ±10 % at 23°C (mA)	Coil resistance ±10 % at 23°C (Ω)	Max. continuous voltage at 70°C	Pick up voltage(Max) at 23°C	Drop out voltage(Min) at 23°C	Power consumption at rated voltage
3	176	17	170 % of rated voltage	75 % of rated voltage	10 % of rated voltage	approx. 0.53W
5	105	47.7				
6	88	68				
9	60	150				
12	44	275				
18	29	618				
24	22	1,100				
48	11	4,400				
60	8.8	6,800				

## »» Specification

Contact material	AgSnO alloy	
Contact resistance <sup>(1)</sup>	100mΩ Max. (1A/6VDC by 4 pipes mΩ meter)	
Operate time <sup>(1)</sup>	20ms Max.	
Release time <sup>(1)</sup>	10ms Max.	
Insulation resistance <sup>(1)</sup>	1000MΩ Min. (DC 500V)	
Dielectric strength <sup>(1)</sup>	Between open contact : AC 1000V , 50/60Hz 1 min.	
	Between contact and coil : AC 4000V , 50/60Hz 1 min. (for 1B,1C)	
	: AC 5000V , 50/60Hz 1 min. (for 1A)	
Vibration resistance	Operating extremes	10~55Hz , amplitude 1.5 mm
	Damage limits	10~55Hz , amplitude 1.5 mm

Shock resistance	Operating extremes	10G
	Damage limits	100G
Life expectancy	Mechanical	10,000,000 operations (frequency 18,000 operations/hr)
	Electrical	100,000 operations (frequency 1,800 operations/hr)
Operating ambient temperature	-40 ~ +70°C (no freezing)	
Weight	Approx. 17 g	

Note : (1) initial value

## »» Safety Approval

Certified	UL	CSA	TUV
File No.	E88991	1616947	R50056914

## »» Safety Approval Rating

UL \ CSA		TUV
NO	NC	
20A 277VAC	16A 250VAC	16A 250VAC
25A 125VAC	25A 125VAC	6A 125VAC $\cos \phi$ 0.5
TV-10	16A 30VDC	16A 30VDC
20A 30VDC	1/2HP 250/125VAC	8A 250VAC $\cos \phi$ 0.4
1/2HP 250/125VAC	8A FLA, 250VAC	
8A FLA, 250VAC		

## »» Outline Dimensions

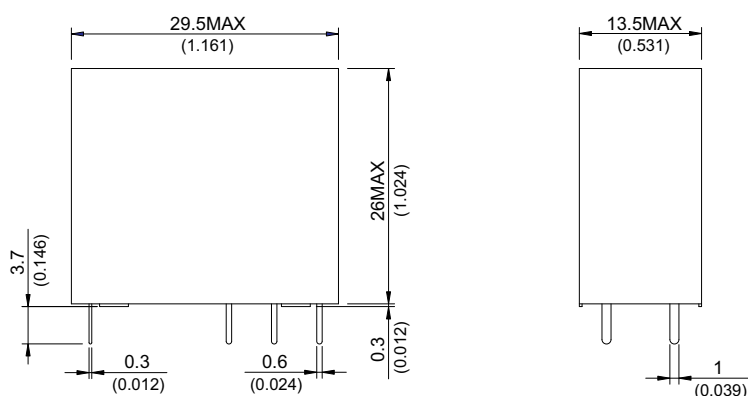

## »» Wiring Diagram BOTTOM VIEW

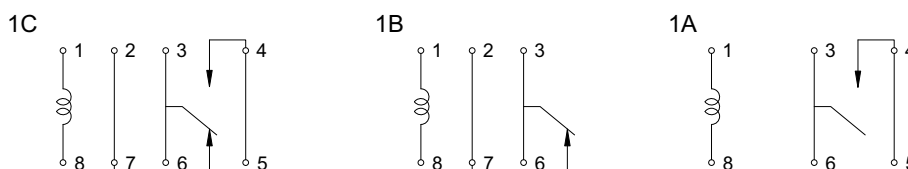

## »» PC Board Layout BOTTOM VIEW

1C

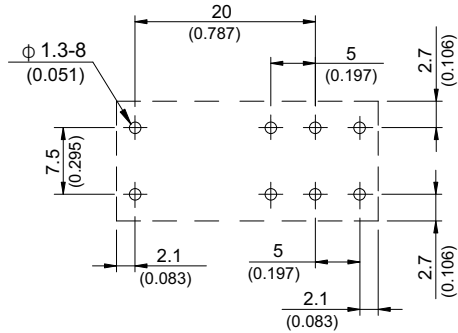

1B

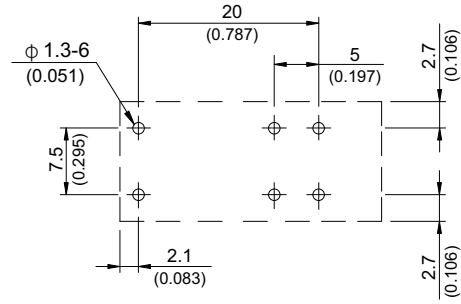

1A

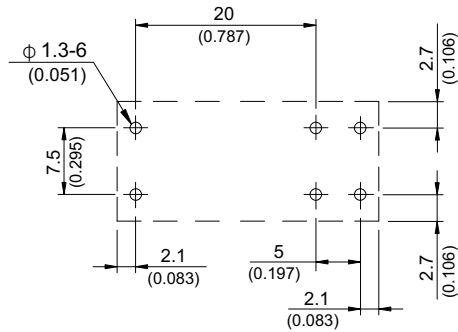

## »» Engineering Data

Coil temperature rise

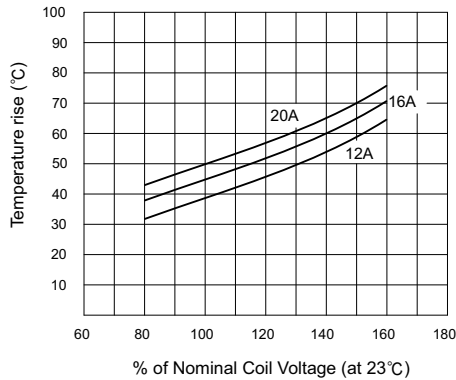

Coil temperature rise

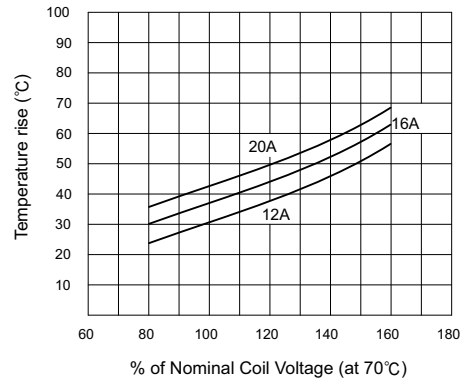

Life expectancy

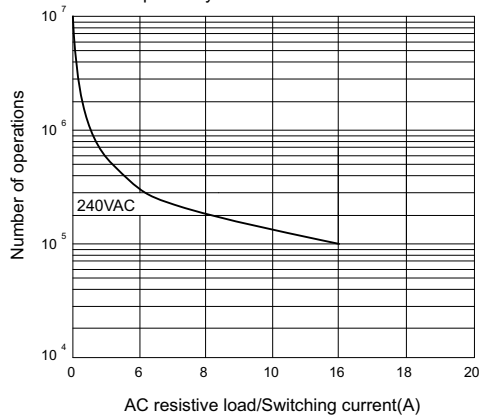

Operate time/Release time

