

Heavy-duty Miniature Relay

- Variety of contact forms: SPDT or SPST-NO (continuous current rating: 8 A)
- Mechanical and electrical characteristics comply with EN61810-1.
- Satisfies EN60335-1 requirements with a dielectric strength of 4 kV at a distance of 8 mm.
- Tracking resistance: CTI>250



RoHS Compliant Refer to pages 16 to 17 for details.



Ordering Information

| Classification | Enclosure ratings | Contact material | Contact form | |
|----------------|-------------------|----------------------------------|--------------|------------|
| | | | SPST-NO | SPDT |
| Standard | Fully sealed | Ag Alloy + gold plating (0.35 μ) | G6RN-1A | G6RN-1 |
| | | Ag Alloy + gold plating (4 μ) | G6RN-1A-AP4 | G6RN-1-AP4 |

Note: When ordering, add the rated coil voltage to the model number.

Example: G6RN-1A 24 VDC
└───┘ Rated coil voltage

Model Number Legend

G6RN-□□-□□ VDC
1 2 3 4

1. Number of Poles

1: 1 pole

2. Contact Form

None: SPDT

A: SPST-NO

3. Contact Material

None: Ag Alloy + gold plating (0.35 μ)

AP4: Ag Alloy + gold plating (4 μ)

4. Rated Coil Voltage

5, 12, 24, 48 VDC

Specifications

■ Coil Ratings

| | | | | |
|----------------------|---------------------------------|---------|---------|----------------|
| Rated voltage | 5 VDC | 12 VDC | 24 VDC | 48 VDC |
| Rated current | 43.9 mA | 18.3 mA | 9.2 mA | 5.2 mA |
| Coil resistance | 114 Ω | 655 Ω | 2,620 Ω | 9,210 Ω |
| Must operate voltage | 70% max. of rated voltage | | | |
| Must release voltage | 10% min. of rated voltage | | | |
| Max. voltage | 150% of rated voltage (at 23°C) | | | |
| Power consumption | Approx. 220 mW | | | Approx. 250 mW |

Note: 1. The rated current and coil resistance are measured at a coil temperature of 23°C with a tolerance of ±10%.
2. Operating characteristics are measured at a coil temperature of 23°C.

■ Contact Ratings

| | |
|--------------------------------|--|
| Load | Resistance load (cos φ = 1) |
| Rated load | 8 A at 250 VAC; 5 A at 30 VDC |
| Rated carry current | 8 A |
| Max. switching voltage | 250 VAC; 30 VDC, (400 VAC) (See note.) |
| Max. switching current | AC 8 A; DC 5 A |
| Max. switching power | 2,000 VA; 150 W |
| Failure rate (reference value) | 5 VDC 10 mA (for gold plating 0.35 μ min.) |

Note: P level: λ60 = 0.1 × 10⁻⁶ operations

■ Characteristics

| | |
|--------------------------|--|
| Operate time | Max. 15 ms (Typ. 6 ms) |
| Release time | Max. 5 ms (Typ. 3 ms) |
| Max. operating frequency | Mechanical: 36,000 operations/hr Electrical: 360 operations/hr (under rated load) |
| Insulation resistance | 1,000 MΩ min. (at 500 VDC) |
| Dielectric strength | 4,000 VAC between coil and contacts 1,000 VAC between contacts |
| Creepage/clearance | 8 mm min. between coil and contacts |
| Vibration resistance | Malfunction: NO: 10 to 55 to 10 Hz, 0.75-mm single amplitude (1.5-mm double amplitude) NC: 10 to 55 to 10 Hz, 0.4-mm single amplitude (0.8-mm double amplitude) |
| Shock resistance | Destruction: 1,000 m/s ² Malfunction: NO: 100 m/s ² NC: 50 m/s ² |
| Endurance | Mechanical: 10,000,000 operations min. Electrical: 50,000 operations (Typ. 100,000 operations) |
| Ambient temperature | Operating: -40°C to 85°C (with no icing) |
| Ambient humidity | Operating: 5% to 85% |
| Weight | Approx. 9 g |
| Protection class | II according to VDE0106 Part 1 |
| Insulation class | C/250, B/380 according to VDE0110 |

■ Approved Standards

VDE (EN61810-1)

| Contact form | Coil ratings | Contact ratings |
|-----------------|------------------------------|---------------------------|
| SPDT SPST-NO | 5, 6, 12, 18, 24, 36, 48 VDC | 8 A at 250 VAC (cosφ = 1) |

UL508 (File No. E41515)

| Coil rating | Contact rating |
|-------------|--|
| 5 to 48 VDC | 10 A at 250 VAC (resistive) 5 A at 30 VDC (resistive) 8 A at 250 VAC (resistive) (ambient temperature: 85°C) |

CSA C22.2 (File No. LR31928-543)

| Coil rating | Contact rating |
|-------------|--|
| 5 to 48 VDC | 10 A at 250 VAC (resistive) 5 A at 30 VDC (resistive) 8 A at 250 VAC (resistive) (ambient temperature: 85°C) |

Engineering Data

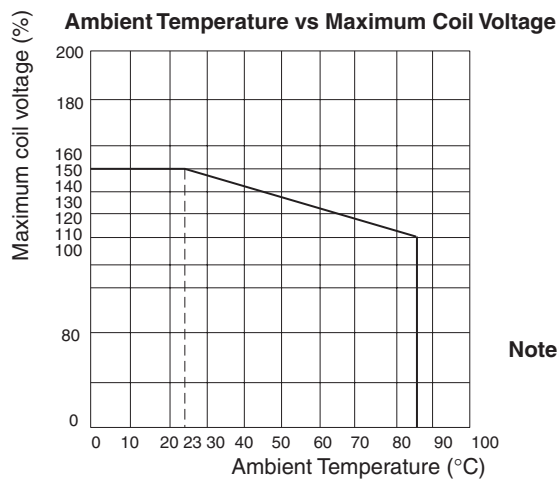
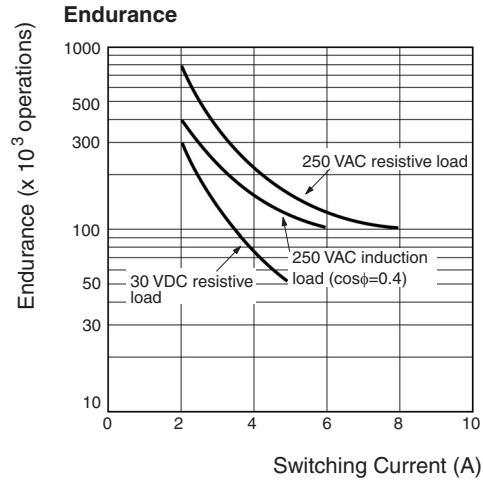
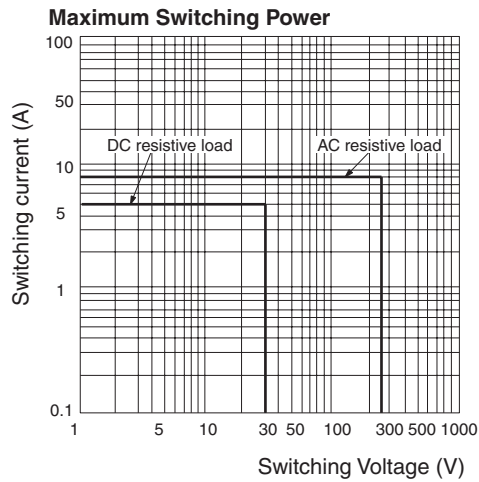

Note: The maximum coil voltage refers to the maximum value in a varying range of operating power voltage, not a continuous voltage.

Dimensions

Note: All units are in millimeters unless otherwise indicated.

SPDT Type

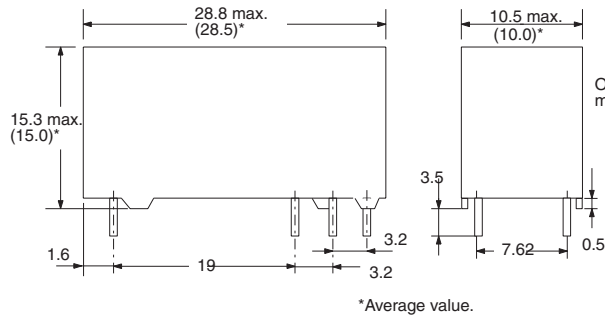
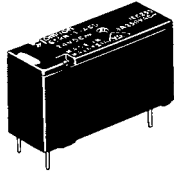

Terminal Arrangement/ Internal Connections (Bottom View)

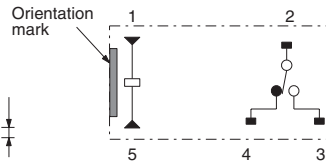

Mounting Holes (Bottom View)

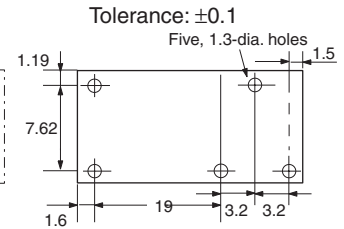

SPST-NO Type

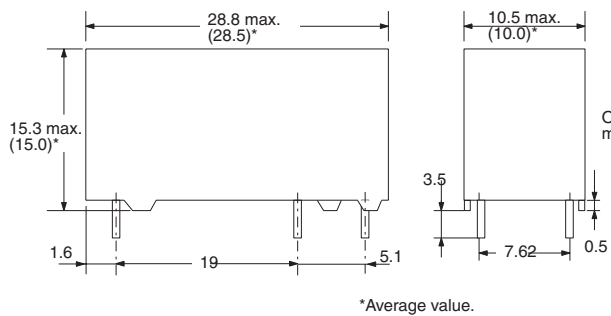
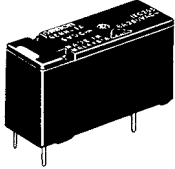

Terminal Arrangement/ Internal Connections (Bottom View)

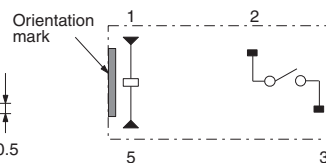

Mounting Holes (Bottom View)

